

TOP VIEW

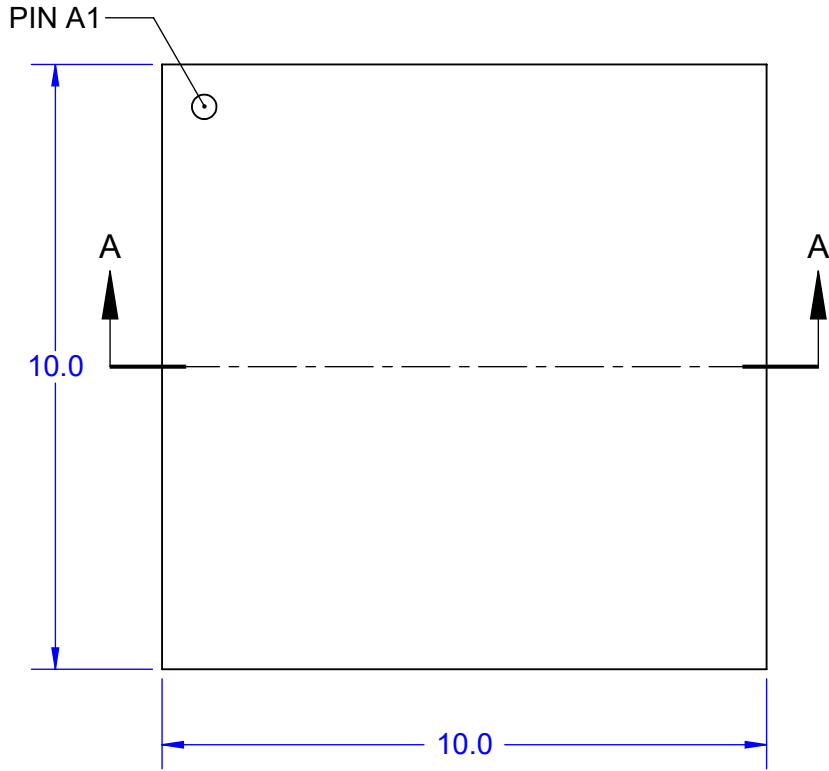

BALL VIEW

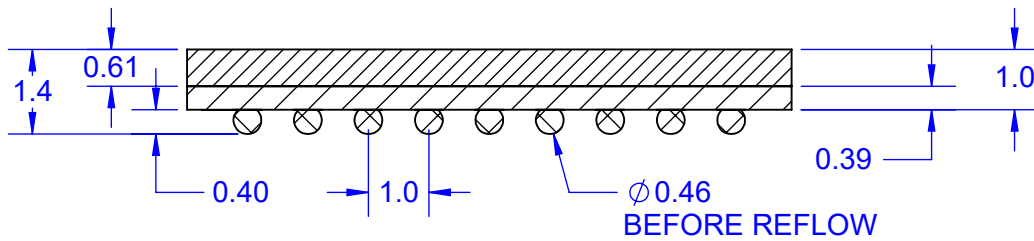
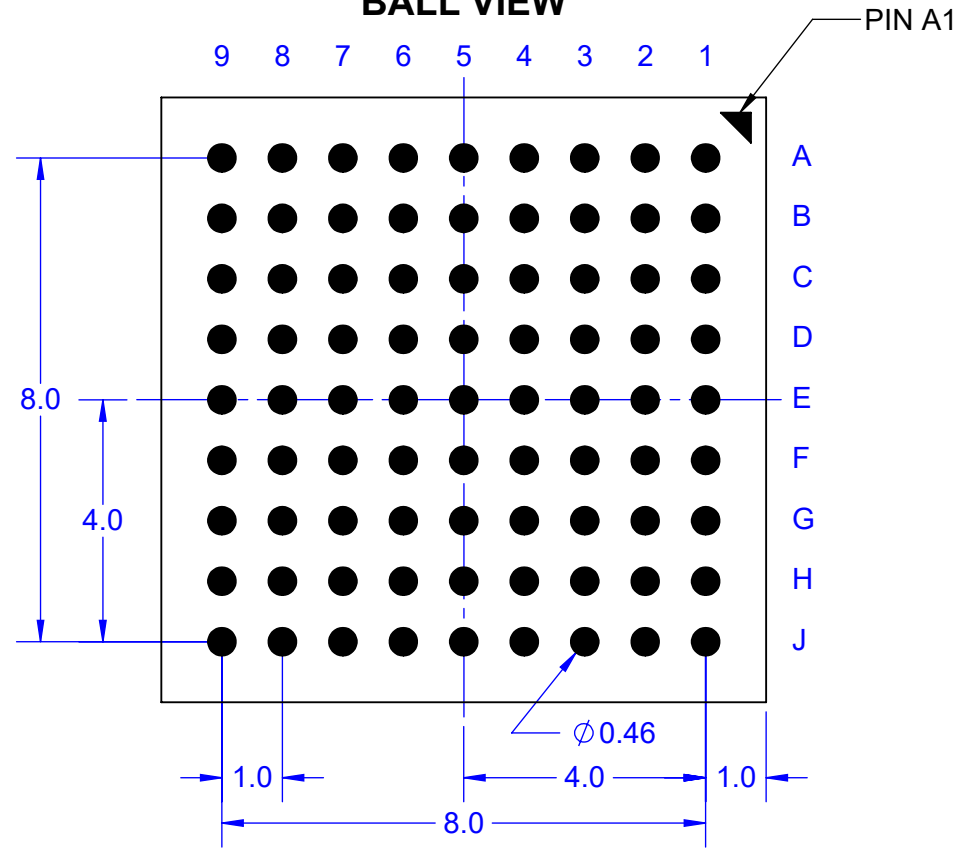

SECTION A-A

Notes: (Unless Otherwise Specified).

- 1) ALL DIMENSIONS MM.
- 2) SOLDER BALL ALLOY: SEE PART NUMBER TABLE.
- 3) BALL DIAMETER (BEFORE REFLOW): 0.46mm [18 MIL].
- 4) SOLDER MASK DEFINED PAD OPENING: 0.36mm [14 MIL].
- 5) PAD Cu DIAMETER: 0.508mm [20 MIL].
- 6) SUBSTRATE MATERIAL: BT.
- 7) DUMMY DIE: OPTIONAL.
- 8) DAISY CHAIN PATTERN (SEE PAGE 2).
- 9) MSL-3 RECOMMEND BAKING 24 HOURS @ 125C TO REMOVE MOISTURE PRIOR TO SOLDERING TO PC BOARD.

PART NUMBER TABLE

PART NUMER	BALL ALLOY	Pb-FREE	RoHS	Si DIE
BGA81T1.0C-ISO	Sn96.5/Ag3.0/Cu0.5	YES	YES	YES
BGA81T1.0-ISO	Sn63/Pb37	NO	NO	YES

APPROVALS	DATE				
DRAWN T.Au	08/17/2022				
ENG M. Hart	08/17/2022	TITLE BGA81T1.0-ISO DUMMY BALL GRID ARRAY			
MFG		SCALE 7:1	SIZE A	DRAWING NO. 510991	REV A
QA		DO NOT SCALE DRAWING			SHEET 1 OF 3
CUST					
REVISED					

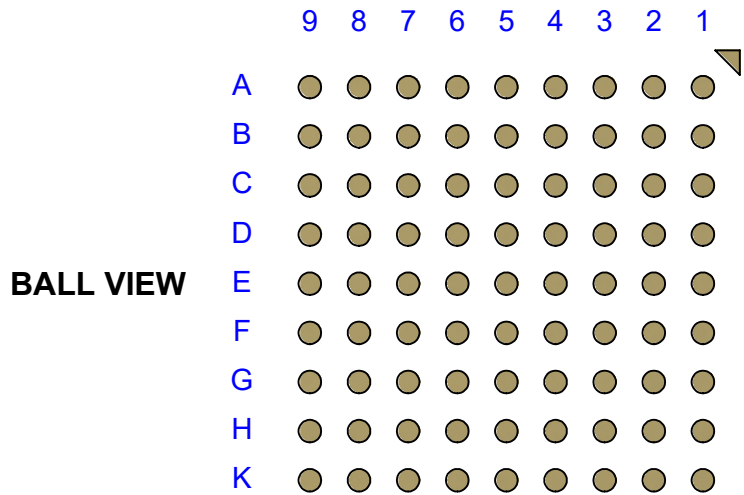

**BOTTOM SIDE
(TOP X-RAY VIEW)**

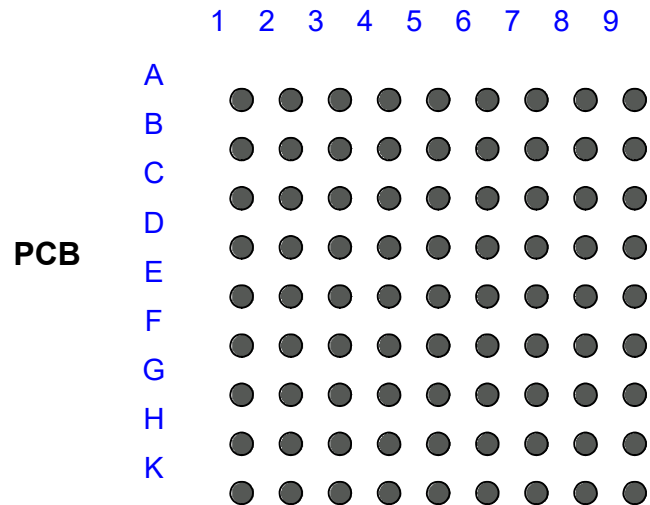
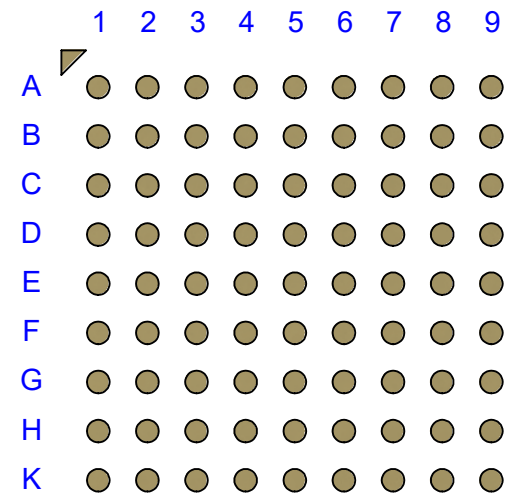

**AFTER MOUNTING
TO TEST BOARD
(TOP X-RAY VIEW)**

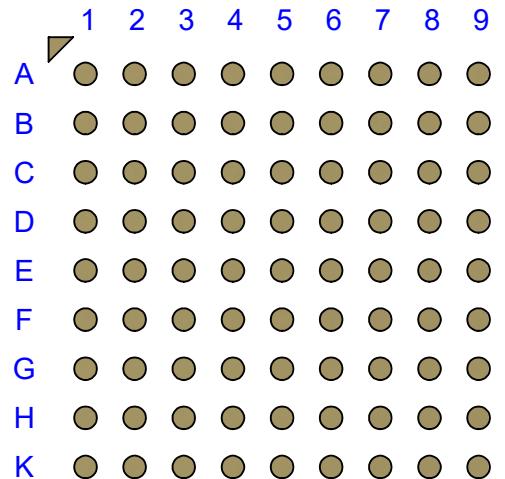

Notes:

- 1) PCB BOARD DIMENSIONS ARE PRESENTED ONLY AS A GUIDELINE. DESIGNERS SHOULD USE THEIR OWN EXPERIENCE WHEN DESIGNING PCB.
- 2) PCB Cu BALL PAD DIAMETER 0.508mm [20 MIL].
- 3) PCB DAISY CHAIN TRACING LINE WIDTH 0.203mm [8 MIL].
- 4) SMD (SOLDER MASK DEFINED) PAD OPENING 0.36mm [14 MIL].

TopLine®			
TITLE BGA81T1.0-ISO DUMMY BALL GRID ARRAY			
SCALE	SIZE	DRAWING NO.	REV
6.5:1	A	510991	A
DO NOT SCALE DRAWING			SHEET 2 OF 3

MODEL

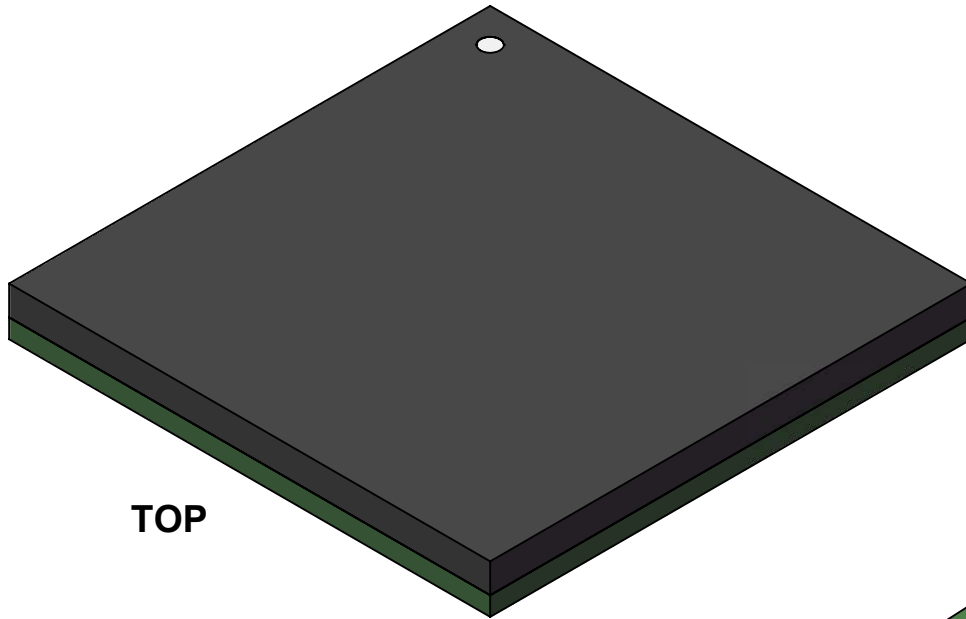

TOP

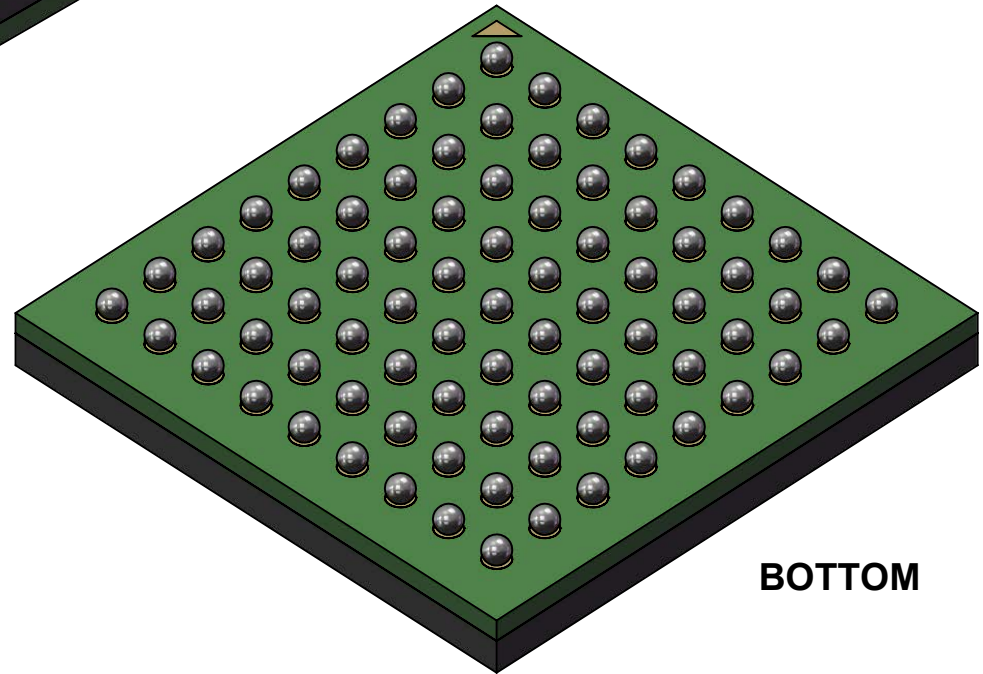

BOTTOM

TopLine[®]

TITLE BGA81T1.0-ISO
DUMMY BALL GRID ARRAY

SCALE 9:1	SIZE A	DRAWING NO. 510991	REV A
--------------	-----------	-----------------------	----------

DO NOT SCALE DRAWING

SHEET 3 OF 3